

Portable Outlet Boxes

Industrial Grade - 8000/3200 Series

Portable Power



Industry Leading Features:

- Non-conductive TPV boxes are crush and jobsite oil resistant.
 - Available in extra deep "quad" size to accommodate a wide range of potential configurations
- Plates are available in outdoor and indoor configurations
 - Boxes are available with rugged cord grip seals that resist moisture and dust penetration.
 - Available with Wire Mesh grips for pendant and rugged use applications
 - Available with feed-through option for stringer applications
- Boxes accommodate 1/2 - 1" openings & counterbored for wire mesh fittings

Industry Leading, Ericson Exclusive

Dimensions:

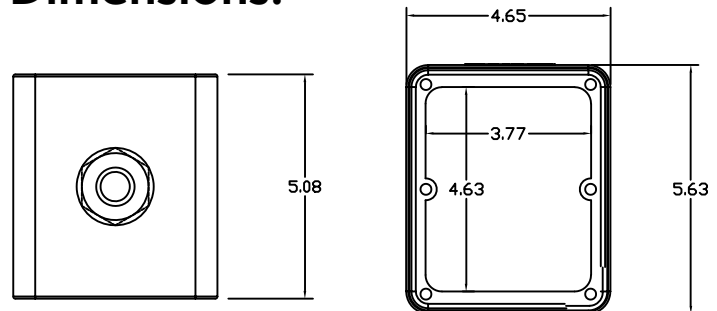

Unique Features:

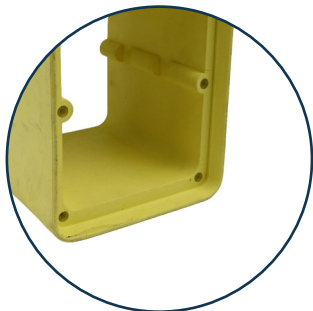

TPV Construction for rugged applications

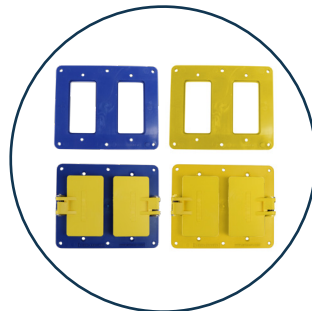

Plates available for indoor and outdoor applications



Compression Grip for secure cable and dust/moisture resistance



Optional mesh available for additional strain relief

8000 Series Selection Guide

8000 Series portable electrical enclosures with large internal wiring area, allows for cords from 18/3 to 6/4 ga. Rugged and durable, these outlet boxes are engineered to provide protection in harsh conditions. **Select wall plates from tables on page 4.**

Part Number	Box Color*	Description	Number of Openings	Cord Clamp Bushing NPT (inch)	Feed-through
8005	Yellow	Box with 1, 1/2" npt Opening and nonmetallic grip	1	1/2"	No
8005B	Black	Box with 1, 1/2" npt Opening and nonmetallic grip	1	1/2"	No
8005F	Yellow	Box with 2, 1/2" npt Openings (1 Opening at each end) and nonmetallic grips	2	1/2"	Yes
8005FB	Black	Box with 2, 1/2" npt Openings (1 Opening at each end) and nonmetallic grips	2	1/2"	Yes
8034	Yellow	Box with 1, 3/4" npt Opening and nonmetallic grip	1	3/4"	No
8034B	Black	Box with 1, 3/4" npt Opening and nonmetallic grip	1	3/4"	No
8034-OR	Orange	Box with 1, 3/4" npt Opening and nonmetallic grip	1	3/4"	No
8034F	Yellow	Box with 2, 3/4" npt Openings (1 Opening at each end) and nonmetallic grips	2	3/4"	Yes
8034FB	Black	Box with 2, 3/4" npt Openings (1 Opening at each end) and nonmetallic grips	2	3/4"	Yes
8010	Yellow	Box with 1, 1" npt Opening and nonmetallic grip	1	1"	No
8010B	Black	Box with 1, 1" npt Opening and nonmetallic grip	1	1"	No
8010F	Yellow	Box with 2, 1" npt Openings (1 Opening at each end) and nonmetallic grips	2	1"	Yes
8010FB	Black	Box with 2, 1" npt Openings (1 Opening at each end) and nonmetallic grips	2	1"	Yes

Environmental rating is dependent on the type of plate used (indoor or outdoor)

*Custom colors are available.



Plates available in yellow, blue, black, and orange.

8000 Series Indoor Cover Plates

*8000 Cover Plates are available in blue, orange and black

← 5.250 →

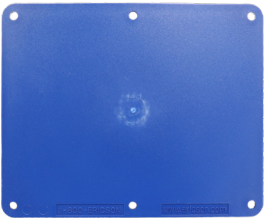

8200

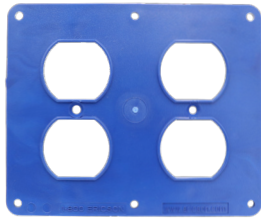

8201

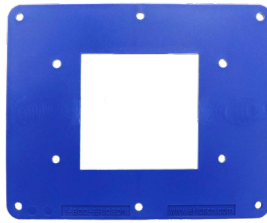

8202

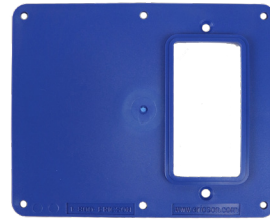

8203

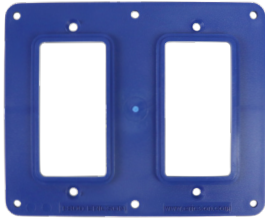

8204

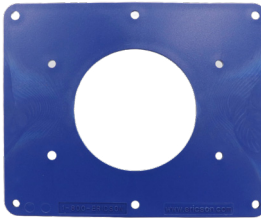

8205

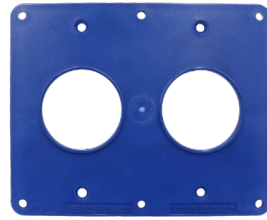

8206

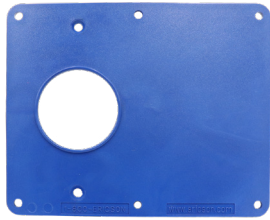

8207

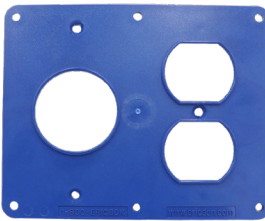

8208

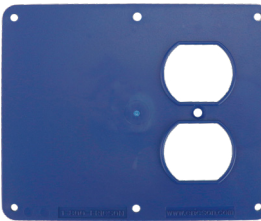

8209

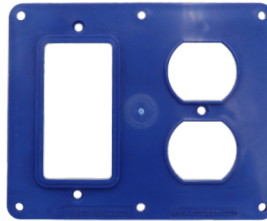

8210

8000 Series Weather Resistant Cover Plates

*8000 Series Weather Proof plates are standard Blue, Black and Orange plate with yellow weather proof covers.available in blue, orange and black

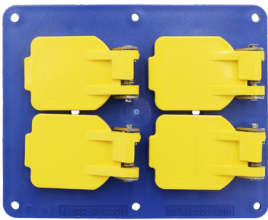

8201FS

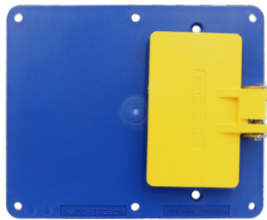

8203FS

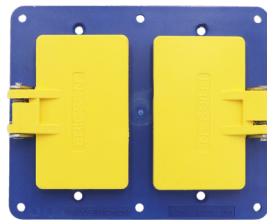

8204FS

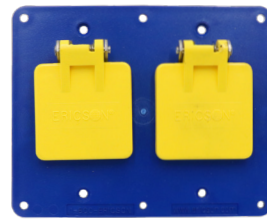

8206FS

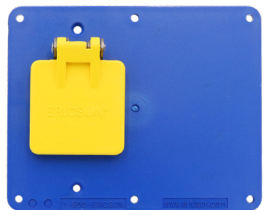

8207FS

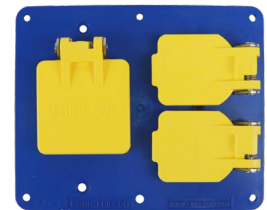

8208FS

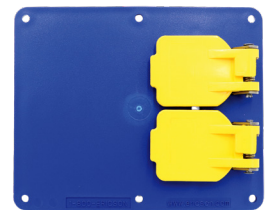

8209FS
8209FS-OR

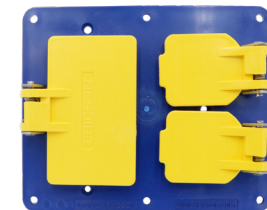

82010FS

8000 Series Indoor Cover Plates

Part Number	Color	"Indoor Cover Plates (WR plates have WR Covers over openings)"	Description
8000 Box Series (2-gang) cover plates			
8200	Blue	Indoor	Blank
8200B	Black	Indoor	Blank
8201	Blue	Indoor	(2) Duplex Receptacles
8201B	Black	Indoor	(2) Duplex Receptacles
8202	Blue	Indoor	(1) GFCI Panel Mount (1075)
8203	Blue	Indoor	(1) GFCI Duplex Receptacle
8203-2	Blue	Indoor	(1) GFCI Duplex with (3) Push Button Breaker Openings
8203B	Black	Indoor	(1) GFCI Duplex Receptacle
8204	Blue	Indoor	(2) GFCI Duplex Receptacles
8204B	Black	Indoor	(2) GFCI Duplex Receptacles
8205	Blue	Indoor	(1) RV TT-30 Receptacle Opening
8206	Blue	Indoor	(2) Single 1.572" Diameter Opening
8206B	Black	Indoor	(2) Single 1.572" Diameter Opening
8207	Blue	Indoor	(1) Single 1.572" Diameter Opening
8207B	Black	Indoor	(1) Single 1.572" Diameter Opening
8208	Blue	Indoor	(1) Duplex Receptacle & (1) Single 1.572" Diameter Opening
8208B	Black	Indoor	(1) Duplex Receptacle & (1) Single 1.572" Diameter Opening
8209	Blue	Indoor	(1) Duplex Receptacle
8209B	Black	Indoor	(1) Duplex Receptacle
8210	Blue	Indoor	(1) Duplex Receptacle & (1) GFCI Duplex Receptacle

8000 Series Weather Resistant Cover Plates

Part Number	Color	Outdoor Cover Plates (WR has covers on plates)"	Description
8000 Box Series (2-gang) cover plates			
8201FS	Blue	Weather Resistant	(2) Duplex Receptacles with Yellow WP Covers
8201FS-OR	Orange	Weather Resistant	(2) Duplex Receptacles with Orange WP Covers
8201FSB	Black	Weather Resistant	(2) Duplex Receptacles with Yellow WP Covers
8203FS	Blue	Weather Resistant	(1) GFCI Duplex Receptacle with Yellow WP Covers
8203FS-2	Blue	Weather Resistant	(1) GFCI Duplex Receptacle with (3) Push Breaker Openings
8203FSB	Black	Weather Resistant	(1) GFCI Duplex Receptacle with Yellow WP Covers
8204FS	Blue	Weather Resistant	(2) GFCI Duplex Receptacles with Yellow WP Covers
8204FSB	Black	Weather Resistant	(2) GFCI Duplex Receptacles with Yellow WP Covers
8206FS	Blue	Weather Resistant	(2) Single 1.572" Diameter Openings with Yellow WP Covers
8207FS	Blue	Weather Resistant	(1) Single 1.572" Diameter Openings with Yellow WP Covers
8208FS	Blue	Weather Resistant	(1) Duplex & (1) Single 1.572" Diameter Openings with Yellow WP Covers
8209FS	Blue	Weather Resistant	(1) Duplex Receptacle with Yellow WP Covers
8209FS-OR	Orange	Weather Resistant	(1) Duplex Receptacle with Orange WP Covers
8209FS-OR-1	Orange	Weather Resistant	(1) Duplex Receptacle with Orange WP Covers with (3) Push Breaker Openings
8209FSB	Black	Weather Resistant	(1) Duplex Receptacle with Yellow WP Covers
8210FS	Blue	Weather Resistant	(1) Duplex Receptacle & (1) GFCI Duplex with Yellow WP Covers

3200 Series Selection Guide

3200 Series portable electrical enclosures with large internal wiring area, allows for cords from 18/3 to 6/4 ga. Rugged and durable, these outlet boxes are engineered to provide protection in harsh conditions. **Select wall plates from tables below.**

Part Number	Color*	Description	Cord Clamp Bushing NPT (inch)
3200	Yellow	Portable Outlet Box 2-Gang Yellow Double Sided 3/4" NPT W/ 2 Blank (3265) Yellow Coverplates	3/4"
3210	Yellow	Portable Outlet Box 2-Gang Yellow Double Sided 3/4" NPT W/ 2 Duplex (3260) Yellow Coverplates	3/4"
3215	Yellow	Portable Outlet Box 2-Gang Yellow Double Sided 3/4" NPT W/ 2 Duplex (3260W) Yellow Coverplates with Flips	3/4"

Environmental rating is dependent on the type of plate used (indoor or outdoor)

*Custom colors are available.

3200 Series Indoor Cover Plates

* Cover plates and weather proof covers are yellow.

← 5.250 →

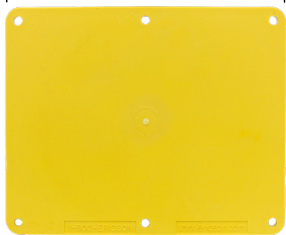

3265

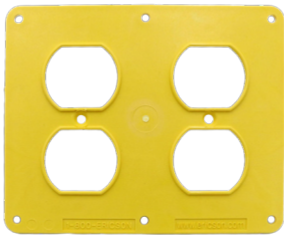

3260

(2) DUPLEX RECEPTACLES



3263

(2) SINGLE 1.572" DIAMETER OPENING

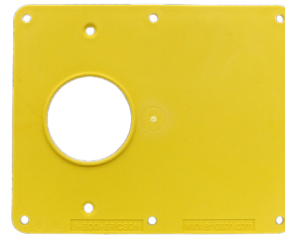

3261

(1) SINGLE 1.572" DIAMETER OPENING

3200 Series Weather Resistant Cover Plates

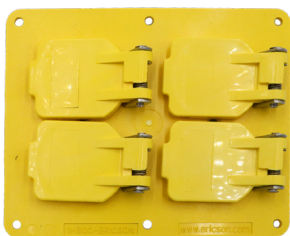

(2) DUPLEX RECEPTACLES WITH YELLOW WP COVERS



(2) SINGLE 1.572" DIAMETER OPENINGS WITH YELLOW WP COVERS



(1) SINGLE 1.572" DIAMETER OPENINGS WITH YELLOW WP COVERS

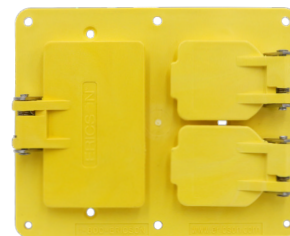

(1) DUPLEX RECEPTACLE & (1) GFCI DUPLEX WITH YELLOW WP COVERS

Diameter Ranges of Portable Electrical Cord in Accordance with UL 62

Type	AWG Size	2 Conductors	3 Conductors	4 Conductors
SJ, SJE, SJOO, SJO, SJEO, SJT, SJTO, SJTOO	18	0.280-0.315	0.300-0.335	0.325-0.365
	16	0.305-0.340	0.325-0.360	0.350-0.395
	14	0.335-0.375	0.360-0.395	0.390-0.435
	12	0.405-0.455	0.425-0.475	0.465-0.520
	10	0.540-0.605	0.565-0.635	0.625-0.700
S, SE, SOO, SO, SEO, ST, STOO, STO	18	0.340-0.385	0.360-0.400	0.385-0.430
	16	0.365-0.410	0.385-0.430	0.410-0.460
	14	0.495-0.550	0.520-0.575	0.560-0.620
	12	0.565-0.625	0.590-0.655	0.640-0.710
	10	0.615-0.685	0.650-0.720	0.700-0.775

8000 and 3200 Series Box Strain Relief Kits

Indoor Galvanized Aluminum Wire Mesh Strain Relief		
Size	Part Number	Cable Range
1/2" NPT	SR-022	.24-.32
1/2" NPT	SR-030	.32-.43
1/2" NPT	SR-040	.43-.54
3/4" NPT	SR-052	.54-.73
1" NPT	SR-070	.73-.97



Dry location only.

Outdoor Watertight Deluxe Stainless Steel Wire Mesh Strain Relief		
Size	Part Number	Cable Range
1/2" NPT	DCG-43-F2	.31-.43
1/2" NPT	DCG-50-F2	.37-.50
3/4" NPT	DCG-50-F3	.37-.50
3/4" NPT	DCG-62-F3	.50-.62
3/4" NPT	DCG-75-F3	.62-.75
1" NPT	DCG-75-F4	.62-.75
1" NPT	DCG-87-F4	.75-.87
1" NPT	DCG-100-F4	.87-1.0



Replacement Screws for 8000 Series Plates	
Part Number	Description
80SCPKG	Screw Package for 8000 Series Boxes
80SCPKGPL	Screw Package for 8000 Series Plates



Nonmetallic Cord Grips Kit <i>(Includes cord grip insert, grip nut, and lock nut)</i>			
Non-Metallic Cord Grip	Part Number	Cable Range	
1/2" NPT	82005	.30-.62	
1/2" NPT	82005B	.30-.62	
3/4" NPT	82034	.45-.70	
1" NPT	82010	.59-1.0	
Metallic Lock Nuts			
Size	Part		
1/2" NPT	Locknut-50		
3/4" NPT	Locknut-75		
1" NPT	Locknut-100		

Note: 6100 Series are supplied standard with Non-Metallic Cord Grip

MAX CORD DIA. (inch)	B10200XX*					#24
	Small White OVAL #24	Small Orange OVAL #25	Small Yellow #21	Small White #20	Small Red #16	
.160 x .360	OVAL (UF)	.230 x .440	.370	.450	.560	
Catalog #			Yellow	White	Red	
8005	Optional	Optional	✓	✓	✓	
8005B			✓	✓	✓	
8005F			✓	✓	✓	
8005FB			✓	✓	✓	

Note: To build a grommet catalog number replace the "XX" with grommet number desired, e.g. B1020021

*May be ordered separately - Call for details

Related Products:

Click or scan a QR code to learn more about our products.

Scan here to visit ericson.com



6000/3000 Series



6100/3000 Series



Perma-Link



Perma-Grip



Perma-Tite



Smart Monitor



Smart Monitor Watertight IP69K



FS Series



PWDX Series

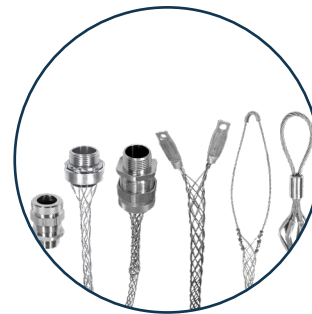

Indoor & Outdoor Wire Mesh



Factory Assembled Power Drops



Industrial Cord Reel Series



Ericson Manufacturing Company
4323 Hamann Parkway
Willoughby, OH 44094, USA



1-800-ERICSON
info@ericson.com
L1000889D
REV 3.26.25